

# Peak-to-Average Power Ratio Reduction Based on Cross-Correlation in Orthogonal Frequency Division Multiplexing Systems

Mohsen Kazemian

Department of Computer and Communication Engineering, University Putra Malaysia, Serdang, Selangor, Malaysia;

Institute of Microelectronics and Wireless Systems, National University of Ireland, Maynooth, Ireland

mohsen\_kazemian@yahoo.com

## ABSTRACT

Three of the most important techniques of Peak-to-average power ratio (PAPR) reduction in orthogonal frequency division multiplexing (OFDM) systems are Partial Transmit Sequence PAPR (PTS-PAPR), Selected Mapping PAPR (SLM-PAPR) and Cross-Correlation-PTS. This paper performs a complete analysis on these three techniques providing simulation and discussion of their performance on PAPR reduction and bit error rate (BER). Moreover, the comparison of these methods by using Saleh model amplifier in an OFDM system is provided. The results show that PTS-PAPR outperforms the Cross-Correlation-PTS in terms of PAPR performance while Cross-Correlation-PTS method is more efficient in BER reduction compared to PTS-PAPR and SLM-PAPR.

**Keywords:** orthogonal frequency division multiplexing, peak-to-average power ratio, bit error rate; partial transmit sequence, selected mapping

Received: 18<sup>th</sup> Jan. 2019      Accepted: 6<sup>th</sup> Apr. 2019      Online: 20<sup>th</sup> Apr. 2019

## 1. Introduction

The characteristics of orthogonal frequency division multiplexing (OFDM) like high data rate and robust reliability are the causes for its adaption in wireless communication systems. The interest in this technique is mainly due to the recent advances in digital signal processing technology. International standards making use of OFDM for high-speed wireless communications are already instated or being instated by IEEE 802.11, IEEE 802.16, IEEE 802.20, and European Telecommunications Standards Institute (ETSI) committees. Orthogonal Frequency Division Multiplexing (OFDM) method has been standardized as the European digital audio broadcasting (DAB), the digital video broadcasting (DVB) and the next mobile communication (LTE) systems.

OFDM technique is the optimum solution for wireless communication systems because it provides greater freedom and exemption to multipath fading and impulse noise without requiring a complex equalizer. Despite advantages of OFDM system, OFDM has a main drawback. Peak-to-average power ratio (PAPR). This is because the high PAPR signal when transmitted through a nonlinear power amplifier causes spectral broadening and system efficiency degradation. Hence, to prevent spectral broadening of the multicarrier signal that creates out-of-band radiation, the power amplifier has to be operated in its linear region. The distribution of PAPR, which bears stochastic characteristics in OFDM systems, often expressed in terms of Complementary Cumulative Distribution Function (CCDF), is the attractive case for Researches. Recently, some researchers have reported on the determination of PAPR distribution based on different theories and also various approaches have been proposed to overcome high PAPR problem such as partial transmit sequence (PTS) that is based on two types: simple PTS<sup>[1-5]</sup> and Cross-correlation PTS<sup>[6]</sup>. In addition some other PAPR techniques are clipping<sup>[7,8]</sup>, clipping and filtering (CAF)<sup>[9]</sup>, companding<sup>[10]</sup>, tone reservation (TR)<sup>[11]</sup>, active constellation extension (ACE)<sup>[12]</sup>, and selected mapping (SLM)<sup>[13]</sup>.

The PTS is the most common PAPR reduction technique because of its less complexity and high PAPR reduction. The PTS can reduce the PAPR significantly, and it is known that the PTS is more advantageous than the SLM in terms of the computational complexity. However, PTS scheme still requires the exhaustive searching time for optimum phase sequences

The most important metrics that should be evaluated are the mean squared error (MSE)<sup>[13]</sup>, inter-modulation distortion (IMD)<sup>[14]</sup>, CCDF<sup>[15]</sup>, peak interference-to-carrier ratio (PICR), PAPR, and bit error rate (BER). An efficient method can be achieved by the best trade-off between the capacity of PAPR reduction and transmission power, data rate loss, implementation complexity, and BER.

Varahram<sup>[3]</sup> proposed a new phase sequence, which has an advantage for the number of IFFTs, but some draw-backs, such as a high number of multipliers in each of iteration, an inability to support high iterations, the need to save a large side information matrix as well as useless iterations due to the random phase sequences, are significant. Therefore  $N \times N$  multiplier operation is required, which leads to a high computational and hardware complexity.

As mentioned earlier PTS method can be implemented in two modes. The first mode is conventional PTS and the second mode is by using Cross-Correlation on PTS. As a short overview on describing the PTS method, the frequency domain and time domain have a role. Dividing the signals to “V” sub-blocks<sup>[1]</sup> at the frequency domain and multiplying them by the desired phase sequence at the time domain is the main issue of the method PTS. Selecting the optimum phase sequence at the most techniques is relevant to PAPR formula, but it can be achieved by Cross-Correlation concept as we will explain more. Our paper explains and illustrates the efficiency of the most significant methods on PAPR and BER reduction, PAPR-PTS method, and Cross-Correlation-PTS method. The previous papers on Cross-Correlation-PTS method have proposed this method without simulating the PAPR performance. So, here the main objective is to perform analysis on these effects for the first time as a new contribution.

This paper is organized as follows. In section II, we introduce the PTS-PAPR method, section III presents the other method named as PTS-Cross-Correlation. Section IV is a description on SLM method. The other two sections are results and conclusion on the effects of these methods on PAPR reduction and BER reduction respectively.

## 2. PAPR-PTS Method

OFDM signals are composed of  $N$  subcarriers modulated by the data sequence  $X=[X_0, X_1, \dots, X_{N-1}]$ , where the data symbols  $X_i$  are selected from an  $M$ -ray quadrature amplitude modulation (QAM) constellation, then using IFFT at the transmitter and FFT at the receiver. We can represent a baseband OFDM signal as follows<sup>[1]</sup>:

$$x(t) = \frac{1}{\sqrt{N}} \sum_{k=0}^{N-1} X(k) e^{j2\pi k \Delta f t} \quad (1)$$

where:  $X(k)$  is the data symbol of  $k$ th subcarrier,  $N$  is the number of subcarriers,  
 $\Delta f$  is the frequency difference between subcarriers,  $T$  is the OFDM symbol duration.

In OFDM the subcarriers are chosen to be orthogonal (i.e.,  $\Delta f = 1/NT$ ).

The PAPR of the transmitted OFDM signal can be defined as<sup>[16]</sup>:

$$PAPR = \frac{\max [ |x(t)|^2 ]}{\frac{1}{NT} \int_0^{NT} [ |x(t)|^2 ] dt} \quad (2)$$

Here, an approximation is needed for the  $NL$  samples of  $x(t)$  where  $L$  is equal to or greater than 1. These  $L$  times samples are represented as a vector  $x=[x_0, x_1, \dots, x_{NL-1}] T$  and obtained as  $x_k$ :

$$x_k = x(kT / L) = \frac{1}{\sqrt{N}} \sum_{n=0}^{N-1} X_n \cdot e^{j2\pi kn \Delta f T / L} \quad K=0,1,\dots,NL-1 \quad (3)$$

Now,  $x_k$  can be explicated as the inverse discrete Fourier transform (IDFT) of data block  $X$  with  $(L-1) N$  zero padding. It is clear that achieving the PAPR of continuous-time signal by Nyquist rate sampling is impossible; so,  $L=4$  can supply acceptable PAPR results<sup>[16]</sup>.

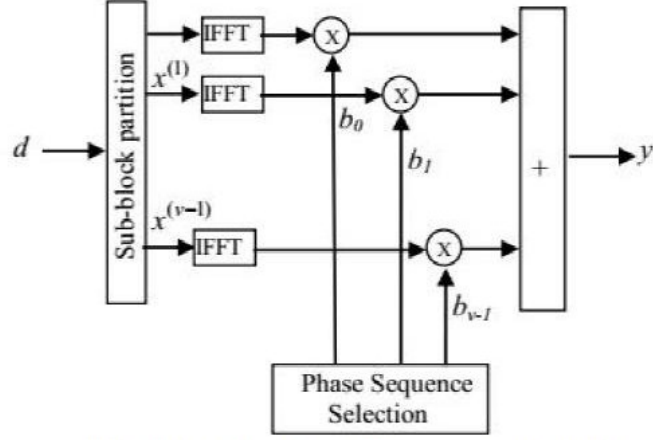

**Figure 1:** Block diagram of the PTS-PAPR method.

By these descriptions, the PAPR equation seems to be as follows:

$$PAPR = \frac{\max \left[ |x(k)|^2 \right]}{E \left[ |x(k)|^2 \right]} \quad (4)$$

Note that  $E[\cdot]$  is the ensemble average.

According to the above formula, PAPR is the maximum envelope of a signal that crosses an amplifier. The numerator conveys the maximum envelope and the denominator represents the ensemble average. PAPR is a random variable because it is a function of the input data, and the input data are random variable. So it can be calculated by using level crossing rate theorem that calculates the average number of times that the envelope of a signal crosses a given level. We can calculate the probability that the amplitude will be above a threshold. The cumulative distribution function (CDF) of the PAPR is one of the most frequently used performance measures for PAPR reduction techniques. The CCDF of the PAPR explains the probability that the PAPR of a data block exceeds a given threshold<sup>[17]</sup>. Hence calculating the CCDF for different PAPR values is needed, as follows:

$$CCDF = \Pr(PAPR > PAPR_0) \quad (5)$$

where  $PAPR_0$  is the threshold of peak to average power ratio. At PAPR-PTS (Conventional PTS) method, the input signal is divided into sub-blocks  $d=[x^{(0)}, x^{(1)}, \dots, x^{(v-1)}]$ , then multiplied by the optimum phases at the time domain to makes the input data for an adder. The output of this adder can be a signal including the minimum PAPR capacity. In other words,

$$y = \sum_{n=0}^{v-1} x^{(n)} b_n$$

where  $b_n$  is the phase sequence,  $\mathbf{b}_n = [b_0, b_1, \dots, b_{v-1}]$ . The objective is to find the phase sequence that minimizes the PAPR; it means the issue is minimization of:

$$\max_{0 \leq k \leq NL-1} |y_k| \quad (6)$$

Figure 1 illustrates PTS-PAPR method.

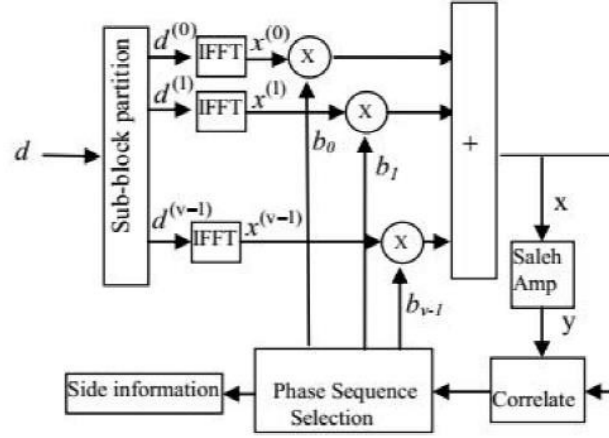

Figure 2. Block diagram of the PTS-Cross Correlation method

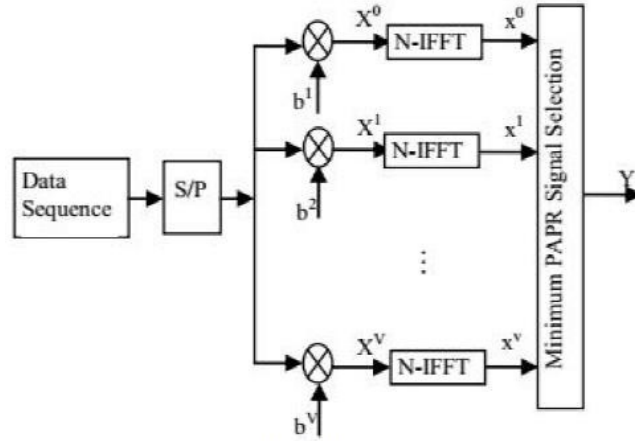

Figure 3; Block diagram of SLM scheme.

### 3. Cross-Correlation PTS Method

In signal processing, cross-correlation is a measure of similarity of two waveforms as a function of a time-lag applied to one of them. This method is based on the statistical description of the Cross-Correlation scheme. Like the above method (PTS-PAPR), the input signal is divided into  $V$  blocks<sup>[6]</sup>:

$$d^{(v)} = \left[ 0^{1 \times vN/V}, \{d\}_{vN/V}^{(v+1)N/V-1}, 0^{1 \times [N-(v+1)N/V]} \right] \quad (7)$$

where  $v$  is in the scale of  $[0, 1, \dots, V-1]$ . For this method, the input of each IFFT block is coming from each branch,

$$X^v = F^H d^{(v)}$$

The  $N^{\text{th}}$  sample can be presented as:

$$x_n^{(v)} = \frac{1}{\sqrt{N}} \sum_{k=0}^{N-1} d_k^{(v)} e^{j \frac{2\pi kn}{N}} \quad n = 0, 1, \dots, N-1 \quad (8)$$

Therefore, we have

$$x = \sum_{v=0}^{V-1} b_v x^{(v)} \quad (9)$$

As we mentioned earlier, if the PAPR amount is up to the specific threshold by entering the HPA (High Power Amplifier), the nonlinear characteristic curve meets that signal so that efficiency is lost. We also know that if the HPA has pure linear characteristic curve or the maximum OFDM signal curve is less than the threshold (the saturation point of the amplifier), the input and output of the amplifier are equal and they are the same; otherwise, they have different amounts.

So, as a description on this method, after dividing the input signals into several sub-blocks and having an IFFT, there is multiplication to the desired phase sequence at the time domain. Hence, the selected phase sequence can be extracted by maximizing the similarity of HPA input and output as follows:

$$R_{xy}^0 = \sum_{n=0}^{N-1} x(n)y(n)^* \quad (10)$$

$$b = \arg_{b(i)} \max R_{xy}^{(0)} \quad (11)$$

Here,  $b(i)$  is the optimum selected phase sequence. The reason is that it satisfies the condition of similarity of the input and output.

For this PTS method, as seen in Figure 2 we used the memory-less nonlinear power amplifier; Saleh model for describing the effects of PAPR in HPA. The AM/AM and AM/PM characteristics of the Saleh model are defined as follows<sup>[2]</sup>:

$$Y[a(t)] = Z_{sat}^2 \frac{x(t)}{x(t)^2 + Z_{sat}^2} \quad (12)$$

$$\phi[a(t)] = \frac{\pi}{6} \frac{x(t)}{x(t)^2 + Z_{sat}^2} \quad (13)$$

Note that we have used  $a=2.5$  as the gain of this amplifier.

Where  $x(t)$  is the absolute value of the input signal,  $Z_{sat}$  describes the amplifier input saturation voltage behaviour, and  $Y[a(t)]$  and  $\phi[a(t)]$  are AM/AM and AM/PM of the power amplifier, respectively.

## 4. CSLM Method

CSLM method is a distortion-less PAPR reduction method and uses no feedback process. Due to no feedback process and simplicity in searching algorithm, CSLM is an efficient crest factor reduction (CFR) technique in OFDM systems, while high number of IFFT blocks is required to achieve desired PAPR performance. Hence high hardware and high computational complexity is main drawback of the CSLM method.

Figure 3 shows the CSLM scheme which uses the original signal sequence  $X$ ,  $V$  times. CSLM generates  $V$  distinct phase rotation vectors  $b^v$  which are known to transmitter and receiver where  $b^v = \{b^v(0), b^v(1), \dots, b^v(N-1)\}$ ,  $b^v(m) \in \{1, -1, j, -j\}$ , and  $0 \leq v \leq V-1$ . The input symbol sequence  $X$  is multiplied by the vector element by element.

As seen in the Figure 1,  $X^v(m)$  is the different alternative representation of the input symbol sequence  $X$ , as  $X^v(m) = X(m) \cdot b^v(m)$ . After passing through the IFFT block,  $x$  as the time domain signal is achieved where  $X^v = IFFT(X^v)$ . Finally, the PAPR values of all  $V$  signals are calculated and selecting the signal with the minimum PAPR value is the last stage as:

$$\tilde{v} = \arg \min \left( \frac{\max |x^v(n)|^2}{\bar{E}[|x^v(n)|^2]} \right) \quad (2)$$

where  $E[.]$  is the expected value operator.

So the  $b^v$  is the optimum phase sequence which is specified as the side information.

## 5. Simulation Results

We have simulated two PTS methods and SLM scheme for PAPR reduction. To simulate these methods, we have used QPSK modulation with IFFT length of  $N=256$ . To obtain the CCDF, 100,000 random OFDM symbols are generated. Also, the number of sub blocks is assumed  $V=4$ .

Figure 4 illustrates the CCDF of PTS-PAPR and Cross-Correlation-PTS methods with approximately 3.5 dB and 3 dB reduction, respectively. We can obtain better results such as 4 dB reduction for PTS-PAPR method and 3.5 dB reduction for the other method depends on the number of sub-blocks and the number of IFFT. It should be noted that in simulation of Cross-Correlation method, the similarity percentage of HPA input and output is 90% and if we are able to increase this amount, then we can achieve the optimum result. Hence the effect of this method on PAPR is simulated and shows that the efficiency of this method on PAPR is not comparable to the PTS-PAPR method, but PTS-Cross-Correlation method has an advantage on BER performance. Also fig.4 shows that the PAPR reduction capacities, related to SLM and Cross-Correlation PTS, are approximately the same as each other.

The other part of our results is based on a comparison between these two methods on BER reduction.

In the case of QPSK modulation and Additive White Gaussian Noise (AWGN) channel as our work, the BER as a function of the  $E_b/N_0$  is given by:

$$BER = 0.5 \operatorname{erfc} \left( \sqrt{\frac{E_b}{N_0}} \right) \quad (14)$$

where  $E_b$  is energy per modulation bit and  $N_0$  is noise spectral density. We have calculated the BER of the PTS-PAPR and Cross-Correlation PTS methods by sampling factor  $L=1$  and  $V=4$  on WIMAX application by using MATLAB software.

As we can observe from Figure 5, the Cross-Correlation-PTS method improves the BER of the OFDM signals while PTS-PAPR method is not effective as well as Cross-Correlation-PTS method in term of BER reduction metric. It means that Cross-Correlation-PTS technique can reduce the BER degradation due the nonlinear characteristics of the power amplifier compare to PTS-PAPR method. As mentioned in the previous stage, if we could increase the similarity of the input and output of the amplifier (more than 90%), we can have more reduction on BER by Cross-Correlation method. There is a trade-off between PAPR reduction and BER performance.

Rayleigh fading models assume that the magnitude of a signal that has passed through such a communications channel will vary randomly, or fade, according to a Rayleigh distribution. Rayleigh fading is a reasonable model when there are many objects in the environment that scatter the radio signal before it arrives at the receiver. Calling this random variable  $\mathfrak{R}$ , it will have a probability density function:

$$P(r) = \frac{2r}{\bar{\sigma}} e^{-r^2/\bar{\sigma}}, \quad r \geq 0$$

where  $\bar{\sigma} = E(\mathfrak{R}^2)$

Figure 6 illustrates the BER degradation performance of the mentioned methods on one path Rayleigh fading environment channel. The results show Cross-Correlation PTS method outperforms PAPR-PTS and SLM method in terms of BER performance.

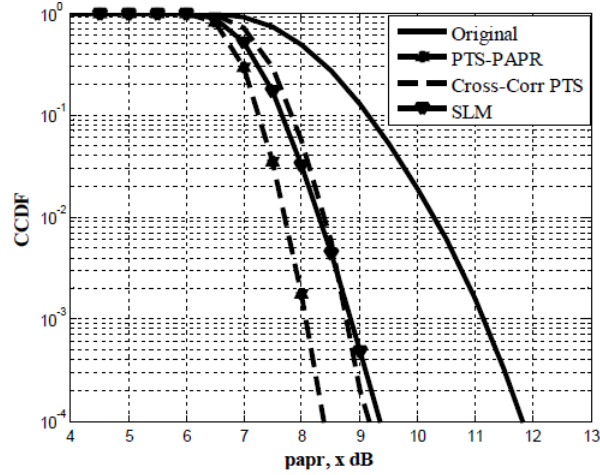

Figure 4: CCDF of the PAPR-PTS method, SLM and Cross-Correlation-PTS method, by  $V=4$ .

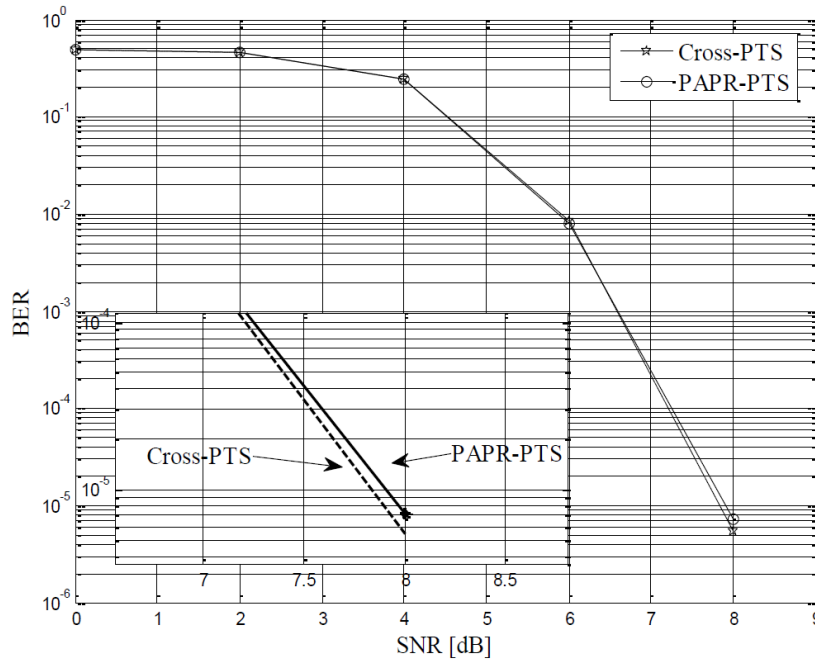

Figure 5. A Comparison for BER Reduction among PAPR-PTS method and Cross -Correlation-PTS method, for AWGN channel.

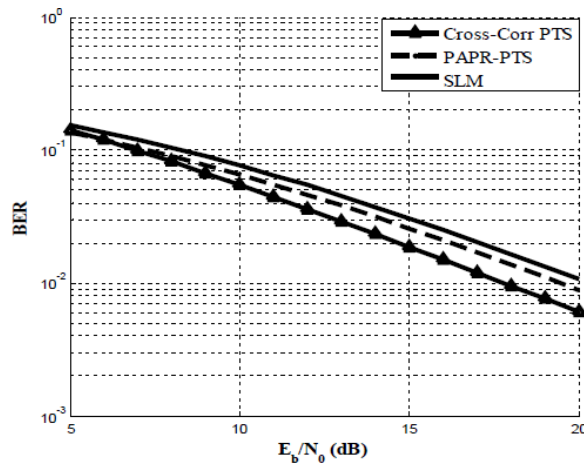

Figure 6: A Comparison for BER Reduction among PAPR-PTS method, Cross -Correlation-PTS method and SLM scheme, for one path Rayleigh fading channel.

## 6. Conclusion

OFDM is the most optimum multiplexing technique in wireless communication systems. The PTS-PAPR, PTS-Cross-Correlation and SLM scheme, are the most recent methods on PAPR reduction. We have simulated the effect of these methods on PAPR reduction and BER reduction as two new results, which has never been done before. These methods reduce the PAPR by selecting the optimum phase sequences and multiplying them to the input sub carriers. The PTS-PAPR select the phase sequence by minimizing the calculation of PAPR, while PTS-Cross-Correlation method does this by maximizing the similarity of the HPA input and output. The PAPR reduction is 3.5dB and 3dB respectively. Also we have simulated the SLM scheme in terms of PAPR reduction which is about similar to Cross-Correlation PTS method. Moreover, this paper investigates a new low complexity technique and compared it by the Conventional PTS and SLM, in terms of BER performance which shows degradation caused by the nonlinear characteristics of the PA. The BER performance of the Cross-Correlation method seems to be better in which reduce BER more than the other methods; also, we can improve the PTS-Cross-Correlation method by increasing its threshold to the amount of up to 90%, which is left for future study. The impact of the PAPR reduction results in enhancement in power efficiency and hence less power consumption and prolonged battery life.

## Acknowledgment

This research is supported by the Prototype Development Research Grant Scheme (PRGS), No. 5528700.

## References

1. P. Varahram, S. Mohammady, M. N. Hamidon, R. M. Sidek and S. Khatun, "Digital predistortion Technique for compensating Memory Effects of Power Amplifiers in Wideband Applications", *Journal of Electrical Engineering*, vol 60, no. 3, 2009.
2. S. Mohammady, P. Varahram, R. M. Sidek, M. N. Hamidon and N. Sulaiman, "Efficiency improvement in microwave power amplifiers by using Complex Gain Predistortion technique," *IEICE Electronics Express (ELEX)*, vol. 7, no. 23, pp.1721-1727, Oct. 2010.
3. P. Varahram; and B. Mohd Ali," Partial Transmit Sequence Scheme with Phase Sequence for PAPR Reduction in OFDM Systems," *IEEE Trans on Consumer Electronics*, Vol. 57, No. 2, May 2011.
4. Pooria Varahram, Somayeh Mohammady; and Borhanuddin Mohd Ali, "A Robust Peak-to-Average Power Ratio Reduction Scheme by Inserting Dummy Signals with Enhanced Partial Transmit Sequence in OFDM Systems", *Wireless Personal Communications*, DOI 10.1007/s11277-013-1058-3, 2013.
5. Pooria Varahram, Borhanuddin Mohd Ali, "Low complexity partial transmit sequence with complex gain memory predistortion in OFDM systems", *Wireless Personal Communications*, DOI: 10.1007/s11277-012-0532-7,2012.
6. E. Al-Dalakta, A. Al-Dweik, A. Hazmi; and C. Tsimenidis, "PAPR Reduction Scheme using Maximum Cross Correlation," *IEEE Communication Letters*, Vol. 16, No. 12, Dec 2010
7. D. Wulich and L. Goldfeld, "Reduction of peak factor in orthogonal multicarrier modulation by amplitude limiting and coding", *IEEE Trans. Commun.*, vol.47, no. 1, pp. 18-21, Jan. 1999.
8. R. J. Baxley and G.T. Zhou, "Comparing selected mapping and partial transmit sequence for PAR reduction", *IEEE Trans. Broadcast.*, vol. 53, no. 4, pp. 797-803, Dec. 2007.
9. J. Armstrong, "peak-to-average power reduction for OFDM by repeated clipping and frequency domain filtering", *Electron. Lett.* vol. 38, no. 5, pp. 246-247, Feb.2002.
10. X. Wang, T. T. Tjhung, and C. S. Ng, "Reduction of peak-to-average power ratio of OFDM system using a companding technique", *IEEE Trans. Broadcast.*, vol.45, no.3, pp. 303-307, Sep.1999.
11. J. Tellado, *Multicarrier Modulation with low PAR: Application to DSL and Wireless*. Norwell, MA: Kluwer, 2000.
12. N. Taspinar, A.Kalinli, and M. Yildirim, "Partial transmit sequences for PAPR reduction using parallel tabu search algorithm in OFDM systems", *IEEE Commun. Lett.*, vol. 15, pp. 974-976, Sep. 2011.
13. B. S. Krongold and D.L. Jomes, "PAR reduction in OFDM via active constellation extension", *IEEE Trans. Broadcast.*, vol. 49, no.3, pp.258-268, Sep.2002.
14. M. R. D. Rodrigues and I. J. Wassell, "IMD reduction with SLM and PTS to improve the error -probability performance of nonlinearly distorted OFDM signals", *IEEE Trans.Veh. Technol.*, vol.55, pp. 537-548, Mar. 2006.
15. S. G. Kang, J. G. Kim and E. K. Joo," A novel subblock partition scheme for partial transmit sequence OFDM", *IEEE Trans. Broadcast.*, vol. 45, no.3, pp. 333-338, September 1999.
16. Seung Hee Han, and Jae Hong Lee, Stanford and Seoul National University. "An Overview of Peak-to-Average Power Ratio Reduction Techniques for Multicarrier Transmission", *IEEE Wireless Communications*, April 2005.
17. C. Tellambura, "Computation of Continuous-Time PAR of an OFDM Signal with BPSK Subcarriers", *IEEE Commun. Lett.*, vol. 5, no.5, May 2001, pp. 185-87.